



at&t

## User's manual

TL7610

DECT 6.0 cordless headset

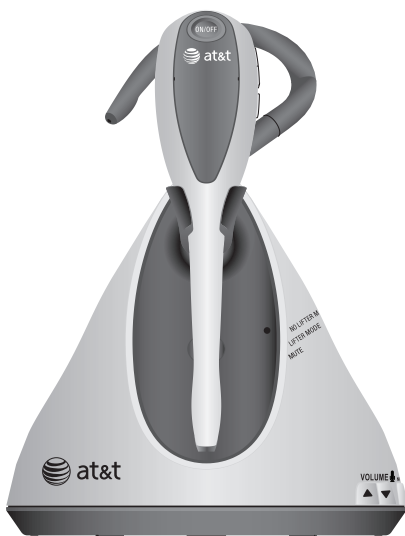

# Congratulations

on your purchase of this AT&T product. Before using this AT&T product, please read the **Important safety information** on pages 45-48 of this manual. Please thoroughly read this user's manual for all the feature operations and troubleshooting information necessary to install and operate your new AT&T product. You can also visit our website at **[www.telephones.att.com](http://www.telephones.att.com)** or call **1 (800) 222-3111**. In Canada, dial **1 (866) 288-4268**.

Model number: TL7610 (Headset and headset base)

Type: DECT 6.0 cordless headset

Serial number: \_\_\_\_\_

Purchase date: \_\_\_\_\_

Place of purchase: \_\_\_\_\_

Both the model and serial numbers of your AT&T product can be found on the bottom of the headset base.

Save your sales receipt and original packaging in case it is necessary to return your product for warranty service.

# Parts checklist

Check to make sure the package includes the following items. Save your sales receipt and original packaging in the event warranty service is necessary.

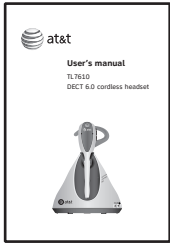

User's manual

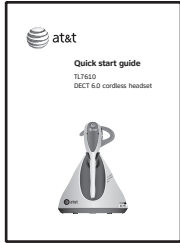

Quick start guide



Cordless headset

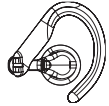

Over the ear hook



Headset base



Battery compartment cover



Battery for headset



Telephone line cords (4-conductor and 2-conductor)



Headset base power adapter



Behind the neck band



Over the head band



Line splitter



Colored label (light blue)

## Optional accessories

The following optional accessories are compatible with your headset and headset base:

- The TL7100 is a handset lifter with an optional external ring detector.
- The TL7600 is an expansion headset (up to two headsets can be used with the same headset base).



TL7100

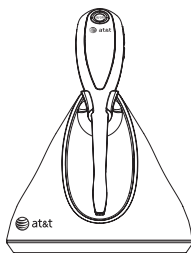

TL7600

Visit our website [www.telephones.att.com](http://www.telephones.att.com) for more information about these products or to download the user's manuals.

# User's manual

TL7610

DECT 6.0 cordless headset



## Table of contents

### Getting started

Quick reference guide - headset.....	1
Headset indicator lights.....	1
Alert tones.....	3
Headset alert tones.....	3
Quick reference guide - headset base.....	4
Headset base indicator lights.....	6
Installation.....	7
Battery installation.....	8
Installation preparation.....	9
Battery charging.....	10
No lifter mode or lifter mode.....	11
Cord labels.....	12
Digital subscriber line (DSL).....	12
Installation options.....	13
Option 1: Headset base with corded or cordless phone installation.....	14
Option 2: Headset base stand-alone installation.....	15

Option 3: Headset base with corded phone for multiple line system or digital business system installation.....	16
Adjust the lifter audio.....	17
Adding and registering a headset.....	18
Registration options.....	18
Option 1: To register a headset to your TL7610 headset base.....	19
Option 2: To register a headset to an AT&T DECT cordless telephone base....	20
Replacing a headset.....	21
To deregister all headsets..	21
Headset attachments.....	22
Over the ear hook.....	22
Over the head band.....	25
Behind the neck band.....	27

### Operation

Headset operation.....	29
Making a call.....	29

Answering a call on the headset .....	30	Operating range.....	59
Ending a call on the headset .....	31	Extended range and clarity .....	59
Auto off .....	31	Index .....	60
Temporary ring tone silencing.....	31		
Options while on calls.....	32		
Volume control.....	32		
Call waiting.....	32		
Switch a call between a handset and headset .....	33		
Multiple headset/handset use.....	34		
Intercom calls and transfers.....	34		
Mute .....	35		

## Appendix

Troubleshooting .....	36
Important safety information.....	45
Safety information.....	45
Especially about cordless headsets .....	46
Precautions for users of implanted cardiac pacemakers .....	48
Pacemaker patients.....	48
Maintenance.....	49
FCC Part 68 and ACTA.....	50
FCC Part 15.....	53
Limited warranty.....	55
Technical specifications .....	59
DECT 6.0 digital technology.....	59

# Quick reference guide - headset

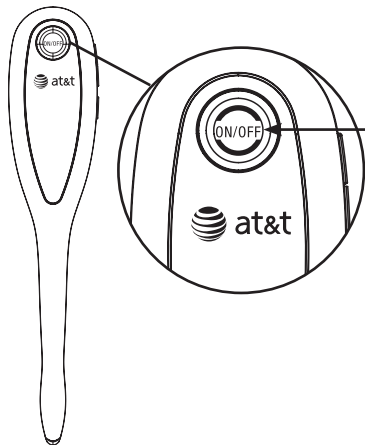

## **ON/OFF**

Press to make, answer, or end a call.

## **Headset indicator lights**

<b>ON/OFF light status</b>	
On	<ul style="list-style-type: none"><li>• Headset is charging in the headset base.</li><li>• Headset is trying to register to the headset base.</li><li>• Headset is searching for the headset base.</li></ul>
Flashing	<ul style="list-style-type: none"><li>• Flashes slowly when an incorrect type of battery is installed.</li><li>• Flashes three times, followed by a pause. This cycle then repeats three more times and then shuts down to indicate the battery is very low.</li><li>• Flashes twice every five seconds to indicate the headset is not registered.</li><li>• Flashes every 20 seconds to indicate the battery is low and needs to be charged in the headset base.</li><li>• Flashes every three seconds to indicate the headset is in use.</li><li>• Flashes quickly when there is an incoming call.</li></ul>

# Quick reference guide - headset

## **VOLUME** /+ -

Press the volume keys on the side of the headset to adjust the listening volume when on a call (page 32).

## **MUTE/FLASH**

Press to mute the microphone during a call (page 35).

Press and hold to answer a call waiting call while on a call (page 32).

Press to mute the ring tone in the earpiece when there is an incoming call.

## **Battery compartment cover**

Remove to install or replace the battery (page 8).

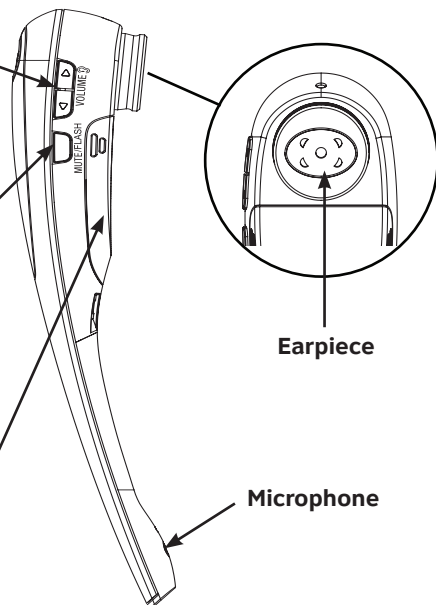

## Alert tones

**Headset alert tones**

Three quick beeps	<ul style="list-style-type: none"> <li>• A <b>VOLUME</b>  <b>/+ -</b> key is pressed when the volume is already at its highest or lowest setting.</li> <li>• The headset is not registered and the headset <b>ON/OFF</b> button is pressed.</li> <li>• The headset is out of range from the headset base during a call.</li> </ul>
One short beep every 20 seconds	Low battery warning.
One short beep every 15 seconds	The call is muted.
One long beep (repeated)	Call waiting alert tone.
One short beep	The headset <b>ON/OFF</b> key is pressed to go on hook or off hook.

# Quick reference guide - headset base

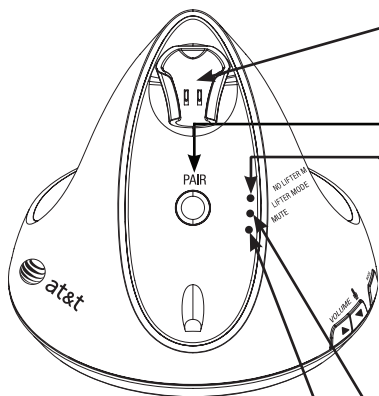

## Charging cradle

Insert the headset here for charging (page 10).

## PAIR

Press and hold to begin headset registration (pages 18-20) or deregistration (page 21).

## NO LIFTER MODE light

On when **NO LIFTER MODE** is selected.

Flashes while on a call, or another telephone is in use on the same line.

Flashes quickly when there is an incoming call.

## LIFTER MODE light

On when **LIFTER MODE** is selected.

Flashes while on a call.

Flashes quickly when there is an incoming call.

## MUTE light

On when a call is muted.

# Quick reference guide - headset base

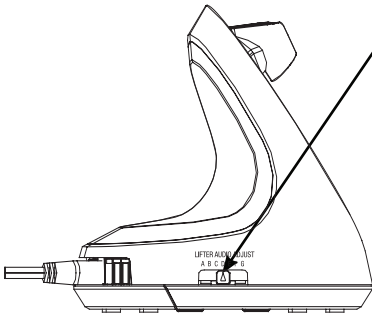

## LIFTER AUDIO ADJUST

Switch to choose the best headset audio quality when using **LIFTER MODE**. See page 17 of this manual or the handset lifter user's manual for more information. You can download the manual at

[www.telephones.att.com](http://www.telephones.att.com).

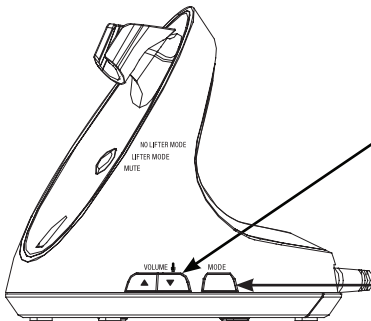

## VOLUME /

Press the volume keys on the side of the headset base to adjust the speaking volume while on a call (page 32).

## MODE

Press to choose between **NO LIFTER MODE** or **LIFTER MODE** when the headset is not in use. The corresponding light turns on (page 11).

## Indicator lights

## Headset base indicator lights

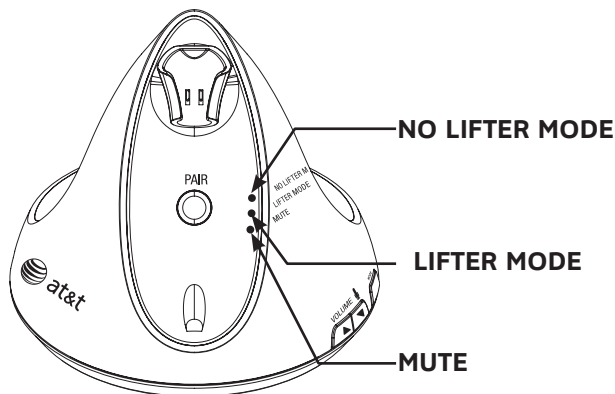

<b>NO LIFTER MODE</b>	<ul style="list-style-type: none"> <li>• On when <b>NO LIFTER MODE</b> is selected (default mode).</li> <li>• Flashes quickly when there is an incoming call.</li> <li>• Flashes when the headset is in use or another telephone on the same line is in use.</li> </ul>
<b>LIFTER MODE</b>	<ul style="list-style-type: none"> <li>• On when <b>LIFTER MODE</b> is selected.</li> <li>• Flashes quickly when there is an incoming call.</li> <li>• Flashes when the headset is in use.</li> </ul>
<b>MUTE</b>	<ul style="list-style-type: none"> <li>• On when a call is muted.</li> <li>• On when you are registering a headset.</li> <li>• Flashes when you are deregistering the headset(s) from the headset base.</li> </ul>

You must install and charge the battery before using the headset.



See pages 8-10 for instructions.

If you subscribe to high-speed Internet service (DSL - digital subscriber line) through your telephone line, you must install a DSL filter between the telephone line cord and the telephone wall jack. The filter prevents noise and caller ID problems caused by DSL interference. Please contact your DSL service provider for more information about DSL filters.

For customer service or product information, visit our website at **[www.telephones.att.com](http://www.telephones.att.com)** or call **1 (800) 222-3111**. In Canada, dial **1 (866) 288-4268**.

**Avoid placing the headset base too close to:**

- Communication devices such as television sets, VCRs or other cordless telephones.
- Excessive heat sources.
- Noise sources such as a window with traffic outside, motors, microwave ovens, refrigerators or fluorescent lighting.
- Excessive dust sources such as a workshop or garage.
- Excessive moisture.
- Extremely low temperature.
- Mechanical vibration or shock such as on top of a washing machine or work bench.

## Battery installation

Install the battery as shown below. After installing the battery, you may be able to make and receive short calls. For optimal performance, charge the headset battery for at least 6 hours before use. When fully charged, the headset battery provides approximately 10 hours of talk time or 5 days of standby time. When the headset is not in use, recharge by returning it to the headset base.

1. If the battery compartment cover is attached, press on both sides of the cover and lift it up and off.

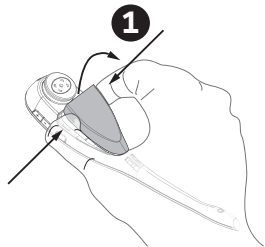

2. Insert the battery into the battery compartment with the label **THIS SIDE UP** facing up.

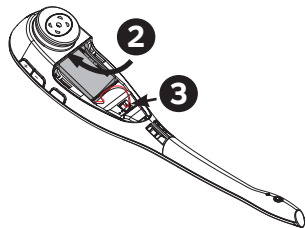

3. Push the battery plug into the connector inside the compartment according to the color-coded label. Place the wires neatly inside the compartment.

4. Insert the tab on the bottom of the battery compartment cover into the battery compartment.

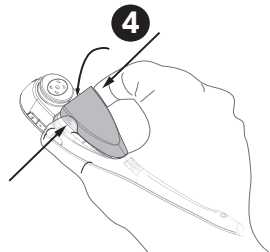

5. Press down gently on the battery compartment cover until it snaps into place.



**NOTE:** Remove the ear hook from the headset (see page 24) before battery replacement.

# Headset base installation

## Installation preparation

---

Before installing the headset base, remove the rear bottom piece of the headset base by pushing it away from the base, as shown in Figure 1.

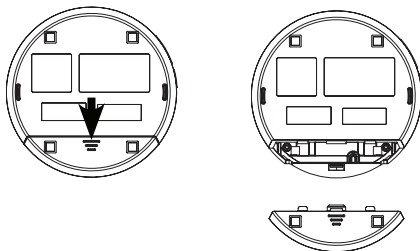

Figure 1

Install the headset base as shown on the following pages.

After completing installation option 1, 2 or 3 (see page 13), slide the rear bottom piece into the headset base until it clicks into place, as shown in Figure 2.

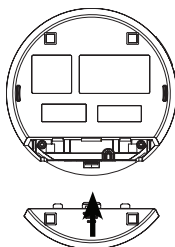
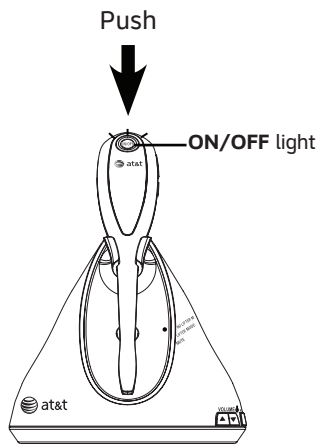
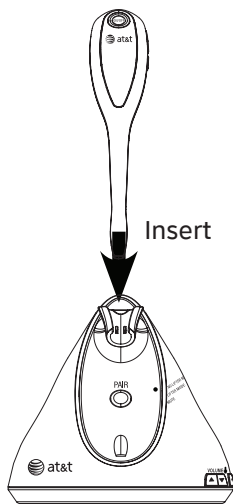

Figure 2

## Battery charging

After installing the battery, charge the headset by placing it in the headset base as shown below. The headset **ON/OFF** light is on when the headset is charging.



1. Insert the headset into the charging cradle.
2. Push the headset downward until the **ON/OFF** light on the headset turns on.

### **CAUTION:**

There may be a risk of detonation if you use a wrong type of battery. Use only the supplied rechargeable battery or replacement battery (model BT191545 "BYD SL531732"). To order, visit our website at **[www.telephones.att.com](http://www.telephones.att.com)** or call **1 (800) 222-3111**. In Canada, dial **1 (866) 288-4268**.

## Headset base installation

### No lifter mode or lifter mode

---

There are two answer modes available on the headset base. The current mode is indicated by the **NO LIFTER MODE** or **LIFTER MODE** lights on the front of the headset base.

- When plugging your headset base into the telephone wall jack (installation option 1 or 2), make sure the headset base mode is set to **NO LIFTER MODE**.

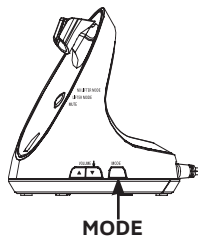

**-OR-**

- When connecting your headset base to a multiple line corded telephone (installation option 3), make sure the headset base mode is set to **LIFTER MODE** and that the **LIFTER AUDIO ADJUST** is switched for the best headset audio quality (see page 17).

### To change the answer mode:

When the headset is not in use, press **MODE** on the headset base to select **NO LIFTER MODE** or **LIFTER MODE**. The corresponding light on the front of the headset base turns on to indicate the current mode.

For complete instructions on installing and using the handset lifter, see the TL7100 handset lifter user's manual. You may also download the manual at [www.telephones.att.com/manuals](http://www.telephones.att.com/manuals).



**NOTE:** If you are using the handset lifter (TL7100 purchased separately), you must use **LIFTER MODE**.

## Headset base installation

### **Cord labels**

---

The cords provided with your headset are attached with colored labels to help you plug them into the correct jacks on the headset base. Each jack on the headset base is labeled and marked with a colored dot, allowing you to plug in the correct cords by matching the colors.

If you are using installation option 3, you can attach the provided light blue colored label to the end of the curly handset cord of your telephone that you plug into the headset base.

### **Digital subscriber line (DSL)**

---

If you subscribe to high-speed Internet service (DSL - digital subscriber line) through your telephone line, you must install a DSL filter between the telephone base and the telephone wall jack. The filter prevents noise and caller ID problems caused by DSL interference. Please contact your DSL service provider for more information about DSL filters.

# Headset base installation

## Installation options

---

**IMPORTANT:** You have three installation options:

**Option 1:** Connect the headset to a corded or cordless telephone (see page 14). You can use the provided line splitter to connect the headset to a telephone.

**Option 2:** Connect the headset to a telephone wall jack (see page 15). This option enables you to use the headset with a single telephone line with or without a telephone.

**Option 3:** Connect the headset base to the curly handset cord of a corded telephone (See page 16).

For this option, you can use the headset with a multiple line corded telephone (such as the AT&T 1080, 1070 or 1040) or a digital business system (such as a proprietary PBX telephone system). This option requires the TL7610 to be in **LIFTER MODE** to operate. You may need to change the **LIFTER AUDIO ADJUST** setting on the base for the best headset audio quality (see page 17).

# Headset base installation

## **Option 1: Headset base with corded or cordless phone installation**

To use this installation option, make sure the headset base mode is set to **NO LIFTER MODE**.

- Plug the small end of the headset base power adapter into the **POWER** jack (green dot) at the back of the headset base.
  - Plug one end of the telephone line cord into the **TEL WALL JACK** (red dot) at the back of the headset base.
  - Plug the other end of the telephone line cord into the line splitter.
  - Plug the line splitter into the telephone wall jack (or DSL filter if you subscribe to DSL Internet service).
  - Plug the headset base power adapter into an electrical outlet not controlled by a wall switch.
  - Connect another telephone line cord between the telephone and the line splitter.
- 
- The diagram illustrates the installation process. At the top, the back of the headset base is shown with a power jack (green dot) and a TEL WALL JACK (red dot). A power adapter is plugged into the power jack, and a telephone line cord is plugged into the TEL WALL JACK. The power adapter is plugged into an electrical outlet. The telephone line cord is plugged into a line splitter, which is then plugged into a telephone wall jack. A DSL filter is also plugged into the telephone wall jack. A cordless or corded phone is connected to the line splitter.
- Cordless or corded phone

# Headset base installation

## Option 2: Headset base stand-alone installation

In order to make calls using this installation option, you need a telephone plugged into the same telephone line. Make sure the headset base mode is set to **NO LIFTER MODE**.

- Plug the small end of the headset base power adapter into the **POWER** jack (green dot) at the back of the headset base.

- Plug one end of the telephone line cord into the **TEL WALL JACK** (red dot) at the back of the headset base.

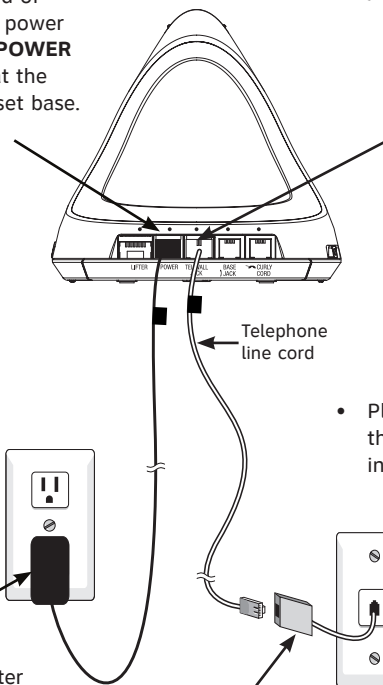

- Plug the headset base power adapter into an electrical outlet not controlled by a wall switch.

- Plug the other end of the telephone line cord into a telephone jack.

A DSL filter (not included) is required if you have DSL high-speed Internet service. The DSL filter must be plugged into the telephone wall jack.

## Headset base installation

### Option 3: Headset base with corded phone for multiple line system or digital business system installation

To use this installation option, adjust the **LIFTER AUDIO ADJUST** switch to choose the best headset audio quality (see page 17). Make sure the headset base mode is set to **LIFTER MODE**.

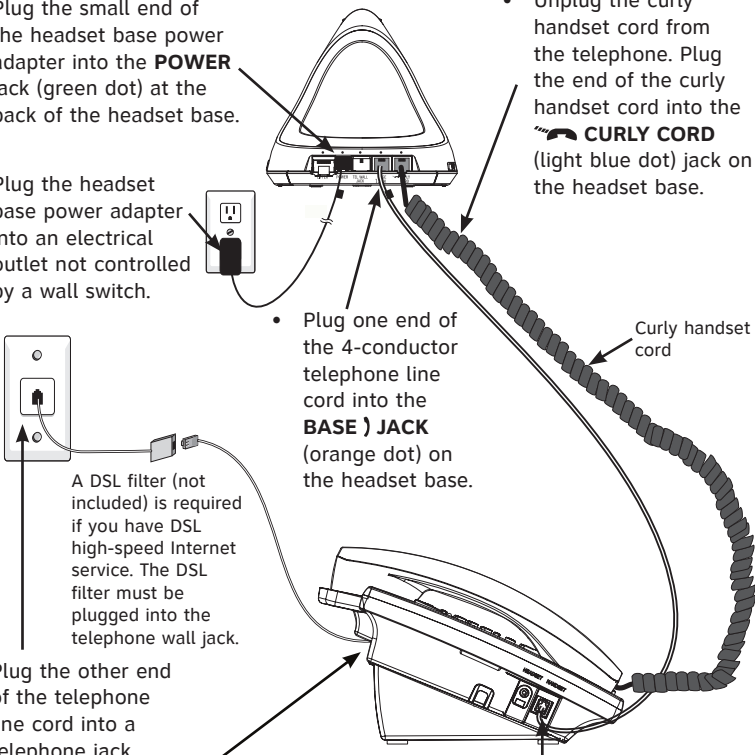
- Plug the small end of the headset base power adapter into the **POWER** jack (green dot) at the back of the headset base.
  - Plug the headset base power adapter into an electrical outlet not controlled by a wall switch.
  - Plug one end of the 4-conductor telephone line cord into the **BASE ) JACK** (orange dot) on the headset base.
  - Plug the other end of the 4-conductor telephone line cord into the handset jack of the corded phone.
  - Unplug the curly handset cord from the telephone. Plug the end of the curly handset cord into the **CURLY CORD** (light blue dot) jack on the headset base.
- 
- A DSL filter (not included) is required if you have DSL high-speed Internet service. The DSL filter must be plugged into the telephone wall jack.

# Headset base installation

## Adjust the lifter audio

---

1. Press **MODE** on the headset base to change the mode if the **LIFTER MODE** light is not on. Make sure that the **LIFTER MODE** light on the headset base is on.
2. Lift the corded handset from the telephone cradle.
3. After you install and charge the battery (see pages 8-10), put the headset next to your ear.
4. Press **ON/OFF** on the headset to listen for a dial tone.
5. If there is no dial tone or the dial tone is not clear, slide the **LIFTER AUDIO ADJUST** switch on the side of the headset base from **A** to **G** until the dial tone is clear.
6. If the dial tone is not clear, repeat step 5 until you find the clearest dial tone.

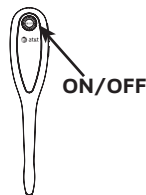
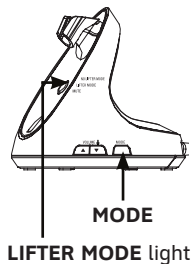



## Adding and registering a headset

### Registration options

---

The TL7610 headset comes pre-registered to the headset base. There are two registration options as described below.

**Option 1:** The TL7610 supports up to two cordless headsets. You can register a TL7600 (purchased separately) headset or a previously deregistered TL7600/TL7610 headset to your TL7610 headset base (see page 19).

**Option 2:** You can deregister your TL7610 headset (see page 21) and then register it to an AT&T DECT 6.0 cordless telephone (see page 20). You can register a maximum of two headsets (TL7610/TL7600) to a cordless telephone. The telephone base recognizes and counts a headset the same as a handset. When you register the headset to an AT&T DECT 6.0 cordless telephone, the headset base acts only as a charger for the headset. The **LIFTER AUDIO ADJUST, VOLUME**  /  and **MODE** controls on the headset base become inactive. You can place the headset base anywhere you have an available power outlet. Do not plug in the telephone line cord; you only need to plug the headset base into a power outlet.

Refer to your telephone user's manual for the maximum number of handsets that you can register to the telephone base. If you have the maximum number of handsets registered, you need to follow the deregistration information in your user's manual. Visit **[www.telephones.att.com/headsets](http://www.telephones.att.com/headsets)** for a list of compatible cordless telephones.

You can only register the headset to one product at a time, so the headset must be deregistered before registering to a headset base or a cordless telephone (see page 21).

The first headset provided with your TL7610 has a blue **ON/OFF** light. When you register a second headset, the **ON/OFF** light of that headset turns orange to help you identify the headsets.

## Adding and registering a headset

### **Option 1: To register a headset to your TL7610 headset base**

---

1. Make sure the battery is properly installed in the headset (see page 8). The **ON/OFF** light flashes twice every five seconds to indicate the headset is not registered.
2. Place the headset in the headset base or charger and allow it to charge for at least five minutes before the registration.
3. Remove the headset from the headset base or charger.
4. Press and hold the **PAIR** button until the **MUTE** light on the headset base turns on (about four seconds) and release the button.
5. Return the headset to the headset base for registration.

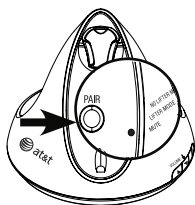

It may take about 30 seconds to complete the registration. The **MUTE** light on the headset base turns off. The headset **ON/OFF** light turns blue on the first headset registered and orange on the second headset registered.

To verify the registration was successful, press the headset **ON/OFF** button and check for a dial tone.

If the registration fails, the **ON/OFF** light on the headset flashes twice every five seconds. To reset the headset, remove the headset from the headset base and try the registration process again.

## Adding and registering a headset

### Option 2: To register a headset to an AT&T DECT cordless telephone base

---

1. You must deregister the headset from the headset base (see page 21).
2. Make sure the battery is properly installed in the headset (see page 8). The **ON/OFF** light flashes twice every five seconds to indicate the headset is not registered.
3. Place the headset in the headset base and allow it to charge for at least five minutes before beginning the registration. Remove the headset from the headset base and then place the headset back into the headset base.
4. On the telephone base of the cordless phone, press and hold the  **HANDSET LOCATOR** button until the **IN USE** light turns on (about four seconds) and then release the button.

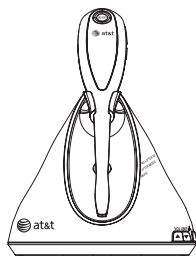

**If your telephone base has no  HANDSET LOCATOR button:**

Press and hold the **HOLD** button until the screen displays **Registering... Please wait**, then release the button.

**-OR-**

Press and hold the  **LOCATOR** button until the screen displays **Registering handset...**, then release the button.

5. The headset is registered to the telephone base automatically. It may take about 30 seconds to complete. The headset **ON/OFF** light turns blue on the first headset registered and orange on the second headset registered. To verify the registration was successful, press the **ON/OFF** button and check for a dial tone.

### **NOTES:**

- If the registration fails, the **ON/OFF** light on the headset flashes twice every five seconds. Reset the headset and try again. Remove the headset from the headset base and press **ON/OFF**. Then place the headset back into the headset base. Try the registration process again.
- For users of Synapse<sup>®</sup>, SynJ<sup>®</sup>, MS2085 Console, or MS2015 Deskset, refer to the user's manual of your respective model for registration instructions.

Synapse<sup>®</sup> and SynJ<sup>®</sup> are trademarks of Advanced American Telephones.

## Replacing a headset

### You may need to deregister your headsets if:

You have two registered headsets and need to replace one of them.

#### -OR-

You wish to change the designated headset number and/or the color of the **ON/OFF** lights of your registered headsets.

#### -OR-

You want to register your headset to an AT&T DECT 6.0 cordless telephone.

You must first deregister both headsets, and then register again each headset you wish to use individually.

**Please read carefully through all the instructions on this page before beginning the deregistration process.**

### To deregister all headsets

---

This procedure deregisters all the items registered to the headset base.

1. Press and hold **PAIR** on the headset base until the **MUTE** light on the headset base turns on and starts to flash (at least 10 seconds), then release **PAIR**.
  2. Immediately press and release **PAIR** again. You must press **PAIR** while the **MUTE** light is still flashing. (The light flashes for about seven seconds. If it stops flashing, start again with step one above.)
  3. Enter the following code on the headset by pressing the keys in this order: **VOLUME**  $\uparrow$ +, **MUTE**, **VOLUME**  $\uparrow$ -, **MUTE**, **VOLUME**  $\uparrow$ +, **VOLUME**  $\uparrow$ -, **MUTE**. When you see the **MUTE** light on the headset base turn off and the headset(s) **ON/OFF** light flashes twice every five seconds, the deregistration is successful. Repeat this step on the other headset if there is any.
- To register the headset(s) to the headset base again, see page 19.



#### NOTES:

- If the deregistration process failed, you may need to reset the system and try again. Remove the headset from the headset base and press **ON/OFF**. Place the headset back into the headset base. You may also reset by unplugging the power from the headset base, then waiting a few seconds, and plugging it back in.
- You cannot deregister the headset(s) if another system headset is in use.
- To deregister all headsets from an AT&T DECT cordless telephone base, see the user's manual of your cordless telephone system, or visit our website at **[www.telephones.att.com](http://www.telephones.att.com)**.

# Headset attachments

## Over the ear hook

---

### To attach the ear hook to the headset:

1. Remove any headset attachment connected to the headset.
2. Insert the earpiece into the ear hook, as shown in Figure 1.
3. Press the ear hook onto the earpiece, as shown in Figure 2.
4. Hook the headset onto the desired ear. Adjust the angle of the headset until the microphone is pointing towards your mouth, as shown in Figure 3.

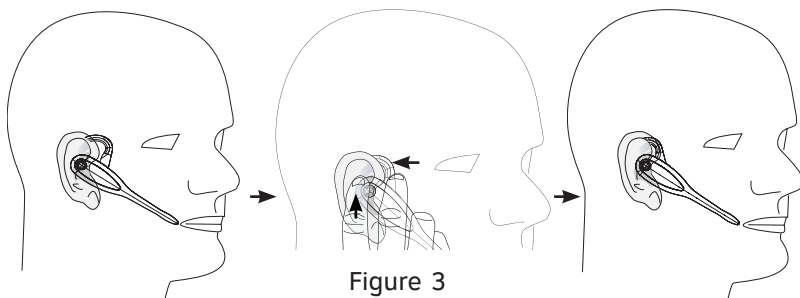
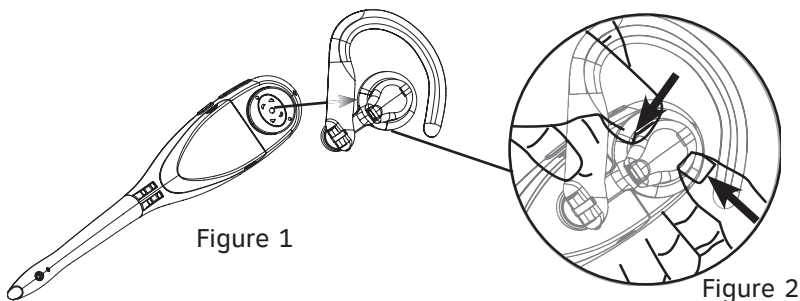

**i** **NOTE:** Firmly grip the earpiece with one hand whenever adjusting the headset microphone up or down, as shown in Figure 3.

# Headset attachments

## To adjust the headset to wear on the other ear:

1. Hold the headset in your hand. Lift the hook upward, as shown in Figure 4.
2. Rotate the hook 180° in a counterclockwise direction, as shown in Figure 5.
3. Push the hook downward, as shown in Figure 6.
4. Hook the headset onto the desired ear. Adjust the angle of the headset until the microphone is pointing towards your mouth, as shown in Figure 7.

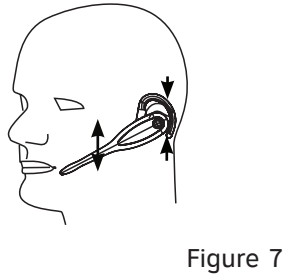
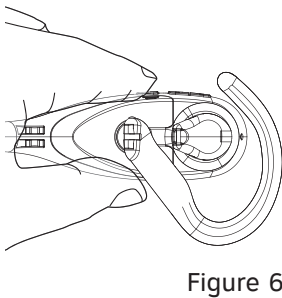
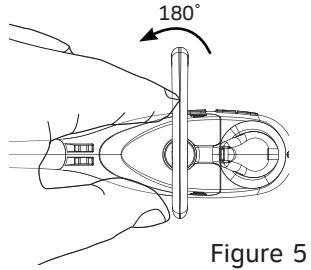
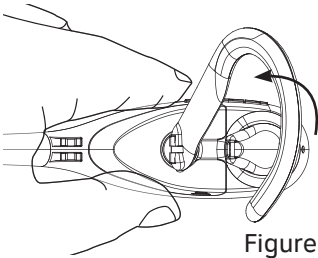

## Headset attachments

### To remove the ear hook from the headset:

Hold the headset with one hand and the ear hook with the other hand. Lift the ear hook up until it separates from the earpiece.

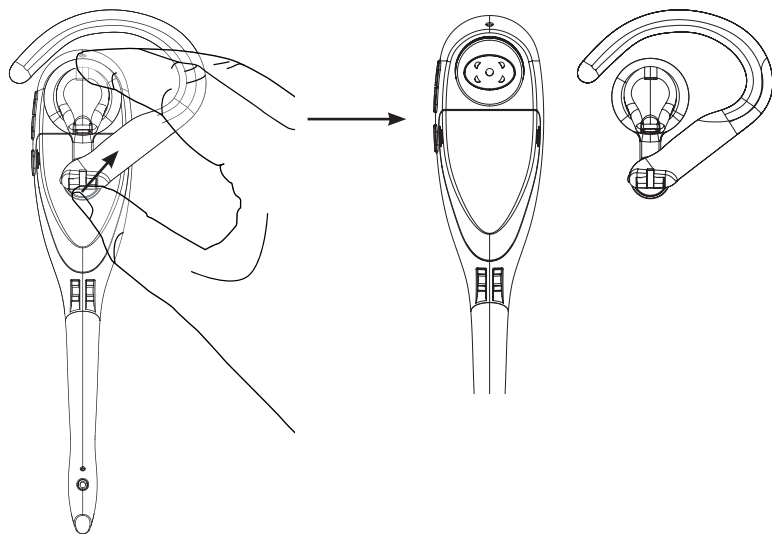

**NOTE:** To wear on the other ear, rotate the headset within the ear pad.

# Headset attachments

## Over the head band

---

**To attach the headband to the headset for wearing on the left or right ear:**

1. Remove any headset attachment currently connected to the headset.
2. Insert the earpiece into the loop of the ear pad, as shown in Figure 8.
3. Gently press the earpiece inward until it clicks into place, as shown in Figure 9.
4. Adjust the headband to fit your head. Adjust and rotate the angle of the headset until the microphone is pointing towards your mouth, as shown in Figure 10.

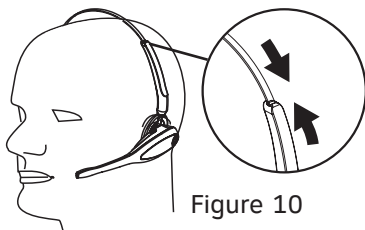
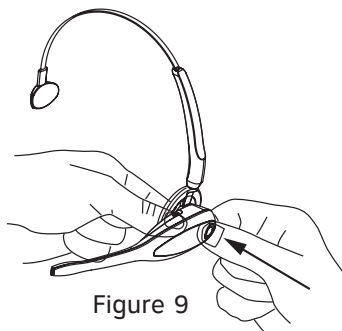
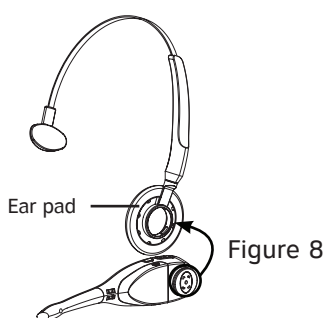

### NOTES:

- To wear on the other ear, rotate the headset within the loop of the ear pad.
- Firmly grip the padded earpiece with one hand whenever adjusting the headset microphone up or down, as shown in Figure 10.

## Headset attachments

### **To remove the headband from the headset:**

Hold the headset with one hand and the headband ear pad with the other hand. Twist and pull the headset until it separates from the ear pad.

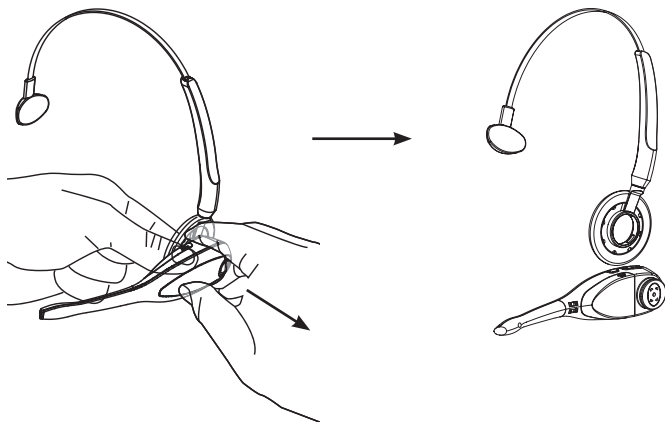

## Headset attachments

### Behind the neck band

---

When first shipped, the ear pad of the neckband is positioned to be worn on the right ear.

#### To wear the headset on your left ear:

1. Remove the ear pad from the neckband by carefully pulling the stem of the ear pad up through the rectangular socket at the end of the neckband, as shown in Figure 11.

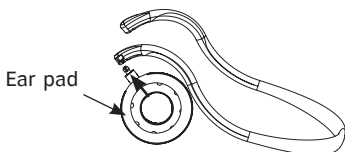

Figure 11

2. Snap the stem of the ear pad into the rectangular socket at the left end of the neckband.

#### To attach the neckband to the headset for wearing on the left or right ear:

1. Remove any headset attachment currently connected to the headset.
2. Insert the earpiece into the loop of the ear pad, as shown in Figure 12.
3. Gently press the earpiece inward until it clicks into place, as shown in Figure 13.

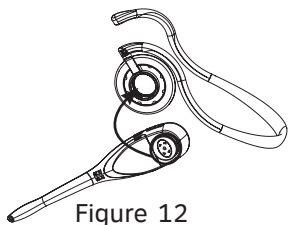

Figure 12

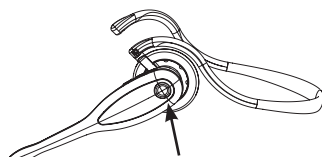

Figure 13

## Headset attachments

4. Place the neckband around your neck and over your ears.
5. Adjust and rotate the angle of the headset until the microphone is pointing towards your mouth, as shown in Figure 4.

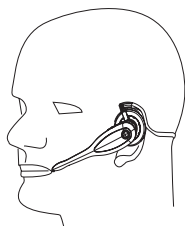

Figure 14



**NOTE:** Firmly grip the padded earpiece with one hand whenever adjusting the headset microphone up or down, as shown in Figure 14.

### To remove the neckband from the headset:

Hold the headset with one hand and the ear pad with the other hand. Twist and pull the headset until it separates from the ear pad.

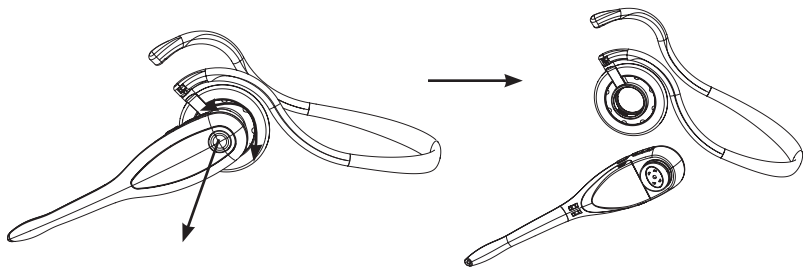

## Headset operation

### Making a call

---

#### **Using the headset base as a stand-alone product (installation option 2):**

- In order to make calls, you need to have a telephone which is already plugged into the same telephone line.

#### **When the headset base is plugged into the telephone wall jack (installation option 1 or 2):**

You must select **NO LIFTER MODE** on the headset base (see page 11).

1. Follow the instructions in your telephone user's manual for making calls.
2. Press **ON/OFF** on the headset at any time to join the call.
3. After you join the call on the headset, you can hang up the telephone and continue the call on the headset.

#### **When the headset base is connected to a multiple line or digital business corded telephone (installation option 3):**

You must select **LIFTER MODE** on the headset base (see page 11).

1. Lift the corded handset from the telephone cradle.
2. Follow the instructions in your telephone user's manual for making calls.
3. Press **ON/OFF** on the headset at any time to switch to the headset.
4. The handset must be out of the cradle (not hung up) until you are ready to end your call.

## Headset operation

### Answering a call on the headset

---

#### When the headset base is plugged into the telephone wall jack (installation option 1 or 2):

- Press **ON/OFF** on the headset.

#### When the headset base is connected to a multiple line or digital business corded telephone (installation option 3):

1. Lift the corded handset from the telephone cradle.
2. Press **ON/OFF** on the headset at any time to switch to the headset.
3. The handset must be away from the cradle (not hung up) until you are ready to end your call.



**NOTE:** The headset base and headset do not have an external ringer. When you receive calls, the headset earpiece plays a ring tone only heard through the earpiece. If you have telephones connected to the same telephone line as the headset base, you can rely on the ringers of those telephones to alert you to incoming calls.

## Headset operation

### Ending a call on the headset

---

#### **When the headset base is plugged into the telephone wall jack (installation option 1 or 2):**

- Press **ON/OFF** on the headset or place the headset in the headset base.

#### **When the headset base is connected to a multiple line or digital business corded telephone (installation option 3):**

1. Press **ON/OFF** on the headset or place the headset in the headset base.
2. Hang up the corded handset by placing it in the telephone base.

### Auto off

---

A call ends automatically when you put the headset in the headset base.

### Temporary ring tone silencing

---

Press **MUTE/FLASH** to temporarily silence the ring tone in the headset earpiece. This silences the ring tone without disconnecting the call. The next incoming call rings at the preset volume.



**NOTE:** If you have more than one headset registered to the headset base, both headsets receive the ring tone when there is an incoming call. Pressing **MUTE/FLASH** on one headset only silences the ring tone of that particular headset.

# Options while on calls

## Volume control

---

### To adjust the listening volume:

While on a call, press the **VOLUME** 📞 /+ - keys on the side of the headset to adjust the listening volume.

### To adjust the speaking volume:

While on a call, press the **VOLUME** 📣 /▲▼ keys on the side of the headset base to adjust the speaking volume.

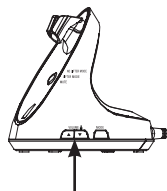

**VOLUME** 📣 /▲▼



### NOTES:

- Listening volume settings are independent for each headset, but the speaking volume is shared by all registered headsets.
- When the volume reaches the minimum or maximum setting, you hear three quick beeps.

## Call waiting

---

If you subscribe to call waiting service offered by your telephone service provider, you hear a beep if there is an incoming call while you are already on a call.

- With installation option 1 or 2, press and hold **MUTE/FLASH** on the side of the headset to put your current call on hold and answer the new call. You can press and hold **MUTE/FLASH** at any time to switch back and forth between calls.
- With installation option 3, you must answer a call waiting call using the corded telephone base (see your telephone user's manual for instructions).

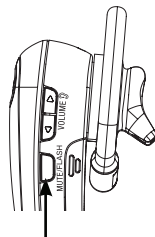

**MUTE/FLASH**

## Options while on calls

### **Switch a call between a handset and headset**

---

#### **When the headset base is plugged into the telephone wall jack (installation option 1 or 2):**

- To switch from the corded handset to a headset while on a call, press **ON/OFF** on the headset, then place the corded handset back into the telephone base.
- To switch from a headset to the corded handset while on a call, lift the corded handset from the telephone base, then press **ON/OFF** on the headset.
- To switch from a cordless handset to a headset while on a call, press **ON/OFF** on the headset, then hang up the cordless handset.
- To switch from a headset to a cordless handset while on a call, press the button you use to answer a call, then press **ON/OFF** on the headset.

#### **When the headset base is connected to a multiple line or digital business corded telephone (installation option 3):**

To switch between a headset and the corded handset while on a call, press **ON/OFF** on the headset.

## Options while on calls

### Multiple headset/handset use

---

Headsets and handsets on the same telephone line can join an external call in progress, creating a conference call. The number of headsets and handsets that can join may be limited by your telephone system. See your telephone user's manual for more information.

To join a call with a headset, press **ON/OFF** on the headset. The conference begins.

To hang up, press **ON/OFF** or place the headset in the headset base.

### Intercom calls and transfers

---

If you have registered your headset to an AT&T DECT cordless telephone, follow the instructions in your telephone user's manual for intercom calls and transfers.

When the cordless handset prompts you to enter a handset number:

- If you have one registered handset, press **#** (pound key) on the cordless handset.
- If you have two registered handsets, press **#1** for headset 1 and **#2** for headset 2.



**NOTE:** You can only make intercom calls or transfers from an AT&T DECT cordless handset to the DECT cordless headset.

## Options while on calls

### **Mute**

---

The mute function allows you to turn off the headset microphone. You can hear the caller, but the caller cannot hear you.

#### **To mute a call:**

- Press **MUTE/FLASH** on the headset to turn off the headset microphone. When the mute feature is on, the **MUTE** light on the headset base turns on and there is a short beep every 15 seconds until this feature is turned off.

#### **To end mute:**

- Press **MUTE/FLASH** on the headset again and resume speaking.

## Troubleshooting

If you have difficulty with your headset, please try the suggestions below. For customer service, visit our website at **www.telephones.att.com** or call **1 (800) 222-3111**. In Canada, dial **1 (866) 288-4268**.

### **My headset doesn't work at all.**

- Make sure the power cord is securely plugged in.
- Make sure the battery connector is securely plugged into the cordless headset.
- Make sure the telephone line cord is securely and firmly plugged into the headset base and the telephone wall jack.
- Charge the battery in the cordless headset for at least 6 hours. For optimum daily performance, return the cordless headset to the headset base when not in use.
- Reset the headset base. Unplug the unit's electrical power. Wait for approximately 15 seconds, then plug it back in. Allow up to one minute for the cordless headset and headset base to reset.
- You may need a new battery. Refer to pages 8-10 of this user's manual.

## Troubleshooting

### **I cannot get a dial tone.**

- First, try all the suggestions above.
- Move the cordless headset closer to the headset base. You might have moved out of range.
- If you are using **LIFTER MODE**, you might need to slide the **LIFTER AUDIO ADJUST** switch (page 17).
- If the previous suggestions do not work, disconnect the headset base from the telephone jack and connect a different phone. If there is no dial tone on that phone either, the problem is in your wiring or telephone service. Contact your telephone service provider.
- Your telephone line cord might be defective. Try installing a new telephone line cord.

### **Nothing happens when I slide LIFTER AUDIO ADJUST to get a clear dial tone.**

- There is no need to change the **LIFTER AUDIO ADJUST** switch when you use **NO LIFTER MODE**. If you cannot get a dial tone, try all the suggestions above.

### **I am getting a buzzing sound on my headset or corded base speakerphone.**

- Your telephone may experience interference from the headset. To overcome this problem, move the headset base at least 12 inches away from the telephone.
- Other electronic products such as HAM radios and other DECT phones can cause interference with your cordless headset. Try installing your headset as far away as possible from these types of electronic devices.

## Troubleshooting

### **I cannot dial out.**

- First, try all the suggestions above.
- Make sure you have a dial tone before dialing. The cordless headset may take a second or two to find the headset base and produce a dial tone. This is normal. Wait an extra second before dialing.
- Eliminate any background noise. Noise from a television, radio or other appliances may cause the headset to not dial out properly. If you cannot eliminate the background noise, try dialing from another room with less background noise.
- If the other phones in your home are having the same problem, the problem is in your wiring or telephone service. Contact your telephone service provider (charges may apply).

### **The other party cannot hear my voice during a call.**

- Adjust the speaking volume during a call (page 32).
- If you are using **LIFTER MODE**, you might need to slide the **LIFTER AUDIO ADJUST** switch (page 17).
- If you are using a handset lifter, see the TL7100 handset lifter user's manual for instructions on setting the **LIFTER AUDIO ADJUST**.

## Troubleshooting

### **My cordless headset isn't performing normally.**

- Make sure the power cord is securely plugged into the headset base. Plug the unit into a different working electrical outlet not controlled by a wall switch.
- Move the cordless headset closer to the headset base. You might have moved out of range.
- Reset the headset base. Unplug the unit's electrical power. Wait for 15 seconds, then plug it back in. Allow up to one minute for the cordless headset and headset base to reset.
- Other electronic products such as HAM radios and other DECT phones can cause interference with your cordless headset. Try installing your headset as far away as possible from these types of electronic devices.

### **I want to use my headset with a different headset base.**

- You need to deregister (page 21) the headset from the current headset base and then register (page 19) it to the new headset base.

## Troubleshooting

### **The batteries do not hold a charge.**

- Make sure that the headset battery is installed and securely plugged into the connector.
- If the cordless headset is in the headset base and the **ON/OFF** light on the headset does not turn on, refer to **The ON/OFF light on the headset is off while charging** on page 44 of this **Troubleshooting** guide.
- Charge the battery in the cordless headset for at least 6 hours. For optimum daily performance, return the cordless headset to the headset base when not in use.
- You may need a new battery. Refer to **Battery charging** on page 10.
- Your headset might be defective. Refer to **Limited warranty** on pages 55-58 for further instructions.

## Troubleshooting

### **I get noise, static, or weak signal even when I'm near the headset base.**

- If you subscribe to high-speed Internet service (DSL - digital subscriber line) through your telephone line, you must install a DSL filter between the telephone line cord and the telephone wall jack. The filter prevents noise and caller ID problems caused by DSL interference. Contact your DSL service provider for more information about DSL filters.
- You may be able to improve the performance of your cordless headset by installing your new headset base as far as possible from any existing cordless telephone system.
- Other electronic products such as HAM radios and other DECT phones can cause interference with your cordless headset. Try installing your headset as far away as possible from these types of electronic devices.
- Do not install this headset near a microwave oven or on the same electrical outlet. You may experience decreased performance while the microwave oven is operating.
- If your headset is plugged in with a modem or a surge protector, plug the headset (or modem/surge protector) into a different location. If this doesn't solve the problem, relocate your headset or modem farther apart from one another, or use a different surge protector.
- Relocate your headset base to a higher location. You may experience better reception by elevating the headset base.
- If the other phones in your home are having the same problem, the problem is in your wiring or telephone service. Contact your telephone service provider (charges may apply).

## Troubleshooting

### **I hear other calls while using my headset.**

- Disconnect the headset base from the telephone jack, and plug in a different telephone. If you still hear other calls, the problem is probably in your building's wiring or telephone service. Contact your telephone service provider.

### **My calls cut in and out while I'm using my cordless headset.**

- Other electronic products such as HAM radios and other DECT phones can cause interference with your cordless headset. Try installing your headset as far away as possible from these types of electronic devices.
- Do not install the headset near a microwave oven or on the same electrical outlet. You may experience decreased performance while the microwave oven is operating.
- If your headset is plugged in with a modem or surge protector, plug the headset (or modem/surge protector) into a different location. If this doesn't solve the problem, relocate your headset or modem farther apart from one another, or use a different surge protector.
- Relocate your headset base to a higher location. You may experience better reception by elevating the base.
- If the other phones in your home are having the same problem, the problem is in your wiring or telephone service. Contact your telephone service provider (charges may apply).

## Troubleshooting

### **I cannot hear a ring tone from the headset when there is an incoming call.**

- If you have pressed **MUTE/FLASH** on the headset when it is ringing, it mutes the ring tone of the headset. The ring tone resumes on the next call.
- If you are using a handset lifter, see the TL7100 handset lifter user's manual.
- You may have too many extension phones on your telephone line to allow all of them to ring simultaneously. Try unplugging some of the other phones.
- The layout of your home or office might be limiting the operating range. Try moving the headset base to another location, preferably on an upper floor.
- Test a working phone at the phone jack. If another phone has the same problem, the problem is the phone jack, wiring or telephone service. Contact your telephone service provider (charges may apply).
- Other electronic products such as HAM radios and other DECT phones can cause interference with your cordless headset. Try installing your headset as far away as possible from these types of electronic devices.
- Remove the battery and install again. Then place the cordless headset in the headset base. Wait for the cordless headset to reestablish its connection with the headset base. Allow up to one minute for this to take place.
- Your telephone line cord might be defective. Try installing a new telephone line cord.

## Troubleshooting

### **The ON/OFF light on the headset is off while charging.**

- Make sure the power and line cords are plugged in correctly and securely.
- Make sure that the battery connector is securely plugged into the cordless headset.
- Push the headset downwards in the headset base charging cradle until the **ON/OFF** light on the headset turns on.
- Unplug the unit's electrical power. Wait for 15 seconds, then plug it back in. Allow up to one minute for the cordless headset and headset base to reset.
- Clean the cordless headset and headset base charging contacts each month using a pencil eraser or cloth.
- Your headset or headset base might be defective. Refer to **Limited warranty** on pages 55-58 for further instructions.

### **Common cure for electronic equipment.**

If the unit does not seem to respond normally, try putting the cordless headset in its base. If it does not seem to respond, do the following (in the order listed):

- Disconnect the power to the headset base.
- Disconnect the cordless headset battery.
- Wait for a few minutes.
- Connect power to the headset base.
- Install the battery again and then place the cordless headset into the headset base.
- Wait for the cordless headset to reestablish its connection with the headset base. Allow up to one minute for this to take place.

## Important safety information



This symbol is to alert you to important operating or servicing instructions that may appear in this user's manual. Always follow basic safety precautions when using this product to reduce the risk of injury, fire or electric shock.

### Safety information

---

- **Read and understand all instructions in the user's manual. Observe all markings on the product.**
- **Avoid using a headset during a thunderstorm.** There may be a slight chance of electric shock from lightning.
- **Do not use the headset to report a gas leak in the vicinity of the leak.** Under certain circumstances, a spark may be created when the adapter is plugged into the power outlet, or when the headset is replaced in its cradle. This is a common event associated with the closing of any electrical circuit. The user should not plug the headset base into a power outlet, and should not put a charged headset into the cradle, if the headset base is located in an environment containing concentrations of flammable or flame-supporting gases, unless there is adequate ventilation. A spark in such an environment could create a fire or explosion. Such environments might include: medical use of oxygen without adequate ventilation; industrial gases (cleaning solvents; gasoline vapors; etc.); a leak of natural gas; etc.
- **Do not use this product near water, or when you are wet.** For example, do not use it in a wet basement or shower, or next to a swimming pool, bathtub, kitchen sink, or laundry tub. Do not use liquids or aerosol sprays for cleaning. If the product comes in contact with any liquids, unplug any line or power cord immediately. Do not plug the product back in until it has dried thoroughly.
- **Install this product in a protected location** where no one can trip over any line or power cords. Protect cords from damage or abrasion.

## Important safety information

- **If this product does not operate normally, see Troubleshooting on pages 36-44 of this user's manual.** If you cannot solve the problem, or if the product is damaged, refer to **Limited warranty** on pages 55-58. Do not open this product except as may be directed in your user's manual. Opening the product or reassembling it incorrectly may expose you to hazardous voltages or other risks.
- **Replace batteries only as described in your user's manual.** Do not burn or puncture batteries — they contain caustic chemicals.
- **This power adapter is intended to be correctly oriented in a vertical or floor mount position.** The prongs are not designed to hold the plug in place if it is plugged into a ceiling, under-the-table or cabinet outlet.



**CAUTION:** Use only the power adapter provided with this product. To obtain a replacement, visit our website at **[www.telephones.att.com](http://www.telephones.att.com)** or call **1 (800) 222-3111**. In Canada, dial **1 (866) 288-4268**.

### Especially about cordless headsets

---

- **Privacy:** The same features that make a cordless headset convenient create some limitations. Telephone calls are transmitted between the headset base and the headset by radio waves, so there is a possibility that your cordless headset conversations could be intercepted by radio receiving equipment within range of the cordless headset. **For this reason, you should not think of cordless headset conversations as being as private as those on corded telephones.**
- **Electrical power:** The headset base of this cordless headset must be connected to a working electrical outlet which is not controlled by a wall switch. **Calls cannot be made from the headset if the headset base is unplugged or switched off, or if the electrical power is interrupted.**

## Important safety information

- **Potential TV interference:** Some cordless headsets operate at frequencies that may cause interference to TVs and VCRs. To minimize or prevent such interference, do not place the headset base of the cordless headset near or on top of a TV or VCR. If interference is experienced, moving the cordless headset farther away from the TV or VCR will often reduce or eliminate the interference.
- **Rechargeable batteries:** This product contains nickel-cadmium, nickel-metal hydride or lithium-ion rechargeable batteries. Exercise care in handling batteries in order not to create a short circuit with conductive material such as rings, bracelets and keys. The battery or conductor may overheat and cause harm. Observe proper polarity between the battery and the battery charger.
- **Lithium-ion rechargeable batteries:** Dispose of these batteries in a safe manner. Do not burn or puncture. Like other batteries of this type, if burned or punctured, they could release caustic material which could cause injury.



The RBRC™ Seal means that the manufacturer is voluntarily participating in an industry program to collect and recycle lithium-ion rechargeable batteries when taken out of service within the United States. These batteries may be taken to a participating local retailer of replacement batteries or recycling center. Or you may call 1-800-8-BATTERY for locations accepting spent Li-ion batteries.



### CAUTION:

- There may be a risk of detonation if you use a wrong type of battery. Use only the battery provided or replacement battery purchased separately (model BT191545 "BYD SL531732").
- Change this product's batteries only in accordance with the instructions and limitations specified in this manual.
- As with any batteries, do not allow conductive materials such as rings, bracelets or keys to come in contact with the metallic parts of the battery. The battery or conductor may overheat and cause harm.

## Important safety information

- Do not open or damage the batteries. Released electrolyte is corrosive and may cause injury to the eyes or skin. The electrolyte may be toxic if swallowed.
  - Do not dispose of the batteries in a fire. Check with local waste management codes for special disposal instructions.
- Important safety information
- To prevent fire or shock hazard, do not expose this product to water or any type of moisture.
  - Observe proper polarity orientation between the battery and metallic contacts.
  - Do not disassemble your headset. There are no user-serviceable parts inside. Refer to qualified service personnel for servicing.

### **Precautions for users of implanted cardiac pacemakers**

Cardiac pacemakers (applies only to digital cordless telephones):

Wireless Technology Research, LLC (WTR), an independent research entity, led a multidisciplinary evaluation of the interference between portable cordless telephones and implanted cardiac pacemakers. Supported by the U.S. Food and Drug Administration, WTR recommends to physicians that:

#### **Pacemaker patients**

- Should keep cordless telephones at least six inches from the pacemaker.
- Should NOT place cordless telephones directly over the pacemaker, such as in a breast pocket, when it is turned ON.
- Should use the cordless telephone at the ear opposite the pacemaker.

WTR's evaluation did not identify any risk to bystanders with pacemakers from other persons using cordless telephones.

## **SAVE THESE INSTRUCTIONS**

## Maintenance

### **Taking care of your headset**

- Your cordless headset contains sophisticated electronic parts, so it must be treated with care.
- Avoid rough treatment.
- Place the headset down gently. Save the original packing materials to protect your headset if you ever need to ship it.

### **Avoid water**

- Your headset can be damaged if it gets wet. Do not use the headset outdoors in the rain, or handle it with wet hands. Do not install the headset base near a sink, bathtub or shower.

### **Electrical storms**

- Electrical storms can sometimes cause power surges harmful to electronic equipment. For your own safety, take caution when using electrical appliances during storms.

### **Cleaning your headset**

- Your headset has a durable plastic casing that should retain its luster for many years. Clean it only with a soft cloth slightly dampened with water or a mild soap.
- Do not use excess water or cleaning solvents of any kind.

Remember that electrical appliances can cause serious injury if used when you are wet or standing in water. If the headset base should fall into water, DO NOT RETRIEVE IT UNTIL YOU UNPLUG THE POWER CORD AND TELEPHONE LINE CORDS FROM THE WALL. Then pull the unit out by the unplugged cords.

## FCC Part 68 and ACTA

This equipment complies with Part 68 of the FCC rules and with technical requirements adopted by the Administrative Council for Terminal Attachments (ACTA). The label on the back or bottom of this equipment contains, among other things, a product identifier in the format US:AAAEQ##TXXXX. This identifier must be provided to your telephone service provider upon request.

The plug and jack used to connect this equipment to premises wiring and the telephone network must comply with applicable Part 68 rules and technical requirements adopted by ACTA. A compliant telephone cord and modular plug is provided with this product. It is designed to be connected to a compatible modular jack that is also compliant. An RJ11 jack should normally be used for connecting to a single line and an RJ14 jack for two lines. See Installation Instructions in the user's manual.

The Ringer Equivalence Number (REN) is used to determine how many devices you may connect to your telephone line and still have them ring when you are called. The REN for this product is encoded as the 6th and 7th characters following the US: in the product identifier (e.g., if ## is 03, the REN is 0.3). In most, but not all areas, the sum of all RENs should be five (5.0) or less. For more information, please contact your telephone service provider.

This equipment may not be used with Party Lines. If you have specially wired alarm dialing equipment connected to your telephone line, ensure the connection of this equipment does not disable your alarm equipment. If you have questions about what will disable alarm equipment, consult your telephone service provider or a qualified installer.

If this equipment is malfunctioning, it must be unplugged from the modular jack until the problem has been corrected. Repairs to this telephone equipment can only be made by the manufacturer or its authorized agents. For repair procedures, follow the instructions outlined under the Limited Warranty.

## FCC Part 68 and ACTA

If this equipment is causing harm to the telephone network, the telephone service provider may temporarily discontinue your telephone service. The telephone service provider is required to notify you before interrupting service. If advance notice is not practical, you will be notified as soon as possible. You will be given the opportunity to correct the problem and the telephone service provider is required to inform you of your right to file a complaint with the FCC. Your telephone service provider may make changes in its facilities, equipment, operation, or procedures that could affect the proper functioning of this product. The telephone service provider is required to notify you if such changes are planned.

If this product is equipped with a corded or cordless handset, it is hearing aid compatible.

If this product has memory dialing locations, you may choose to store emergency telephone numbers (e.g., police, fire, medical) in these locations. If you do store or test emergency numbers, please:

Remain on the line and briefly explain the reason for the call before hanging up.

Perform such activities in off-peak hours, such as early morning or late evening.

## FCC Part 68 and ACTA

### **Industry Canada**

Operation is subject to the following two conditions: (1) this device may not cause harmful interference, and (2) this device must accept any interference, including interference that may cause undesired operation.

The term "IC:" before the certification/registration number only signifies that the Industry Canada technical specifications were met.

The Ringer Equivalence Number (REN) for this terminal equipment is 0.1. The REN is an indication of the maximum number of devices allowed to be connected to a telephone interface. The termination on an interface may consist of any combination of devices subject only to the requirement that the sum of the RENs of all the devices does not exceed five.

This product meets the applicable Industry Canada technical specifications.

## FCC Part 15

This equipment has been tested and found to comply with the requirements for a Class B digital device under Part 15 of the Federal Communications Commission (FCC) rules.

These requirements are intended to provide reasonable protection against harmful interference in a residential installation. This equipment generates, uses and can radiate radio frequency energy and, if not installed and used in accordance with the instructions, may cause harmful interference to radio communications. However, there is no guarantee that interference will not occur in a particular installation.

If this equipment does cause harmful interference to radio or television reception, which can be determined by turning the equipment off and on, the user is encouraged to try to correct the interference by one or more of the following measures:

- Reorient or relocate the receiving antenna.
- Increase the separation between the equipment and receiver.
- Connect the equipment into an outlet on a circuit different from that to which the receiver is connected.
- Consult the dealer or an experienced radio/TV technician for help.

Changes or modifications to this equipment not expressly approved by the party responsible for compliance could void the user's authority to operate the equipment.

This device complies with Part 15 of the FCC Rules. Operation is subject to the following two conditions: (1) this device may not cause harmful interference, and (2) this device must accept any interference received, including interference that may cause undesired operation. Privacy of communications may not be ensured when using this device.

## FCC Part 15

To ensure safety of users, the FCC has established criteria for the amount of radio frequency energy that can be safely absorbed by a user or bystander according to the intended usage of the product. This product has been tested and found to comply with the FCC criteria. The headset may be safely held against the ear of the user. The headset base shall be installed and used such that parts of the user's body other than the hands are maintained at a distance of approximately 20 cm (8 inches) or more.

This Class B digital apparatus complies with Canadian ICES-003.

## Limited warranty

The AT&T brand is used under license - any repair, replacement or warranty service, and all questions about this product should be directed to: In the United States of America, visit

**www.telephones.att.com** or call **1 (800) 222-3111**.

In Canada, dial **1 (866) 288-4268**.

### **1. What does this limited warranty cover?**

The manufacturer of this AT&T branded product warrants to the holder of a valid proof of purchase (“CONSUMER” or “you”) that the product and all accessories provided in the sales package (“PRODUCT”) are free from defects in material and workmanship, pursuant to the following terms and conditions, when installed and used normally and in accordance with the PRODUCT operating instructions. This limited warranty extends only to the CONSUMER for products purchased and used in the United States of America and Canada.

### **2. What will be done if the PRODUCT is not free from defects in materials and workmanship during the limited warranty period (“materially defective PRODUCT”)?**

During the limited warranty period, the manufacturer’s authorized service representative will repair or replace at the manufacturer’s option, without charge, a materially defective PRODUCT. If the manufacturer repairs the PRODUCT, they may use new or refurbished replacement parts. If the manufacturer chooses to replace the PRODUCT, they may replace it with a new or refurbished PRODUCT of the same or similar design. The manufacturer will retain defective parts, modules, or equipment. Repair or replacement of the PRODUCT, at the manufacturer’s option, is your exclusive remedy. The manufacturer will return repaired or replacement products to you in working condition. You should expect the repair or replacement to take approximately 30 days.

## Limited warranty

### **3. How long is the limited warranty period?**

The limited warranty period for the PRODUCT extends for ONE (1) YEAR from the date of purchase. If the manufacturer repairs or replaces a materially defective PRODUCT under the terms of this limited warranty, this limited warranty also applies to repaired or replacement PRODUCT for a period of either (a) 90 days from the date the repaired or replacement PRODUCT is shipped to you or (b) the time remaining on the original one-year limited warranty; whichever is longer.

### **4. What is not covered by this limited warranty?**

This limited warranty does not cover:

- PRODUCT that has been subjected to misuse, accident, shipping or other physical damage, improper installation, abnormal operation or handling, neglect, inundation, fire, water, or other liquid intrusion; or
- PRODUCT that has been damaged due to repair, alteration, or modification by anyone other than an authorized service representative of the manufacturer; or
- PRODUCT to the extent that the problem experienced is caused by signal conditions, network reliability or cable or antenna systems; or
- PRODUCT to the extent that the problem is caused by use with non-AT&T accessories; or
- PRODUCT whose warranty/quality stickers, PRODUCT serial number plates or electronic serial numbers have been removed, altered or rendered illegible; or
- PRODUCT purchased, used, serviced, or shipped for repair from outside the United States of America or Canada, or used for commercial or institutional purposes (including but not limited to products used for rental purposes); or

## Limited warranty

- PRODUCT returned without a valid proof of purchase (see item 6 below); or
- Charges for installation or setup, adjustment of customer controls, and installation or repair of systems outside the unit.

### 5. How do you get warranty service?

To obtain warranty service in the United States of America, visit **www.telephones.att.com** or call **1 (800) 222-3111**. In Canada, call **1 (866) 288-4268**.

NOTE: Before calling for service, please review the user's manual; a check of the PRODUCT's controls and features may save you a service call.

Except as provided by applicable law, you assume the risk of loss or damage during transit and transportation and are responsible for delivery or handling charges incurred in the transport of the PRODUCT(s) to the service location. The manufacturer will return repaired or replaced PRODUCT under this limited warranty to you. Transportation, delivery or handling charges are prepaid. The manufacturer assumes no risk for damage or loss of the PRODUCT in transit. If the PRODUCT failure is not covered by this limited warranty, or proof of purchase does not meet the terms of this limited warranty, the manufacturer will notify you and will request that you authorize the cost of repair prior to any further repair activity. You must pay for the cost of repair and return shipping costs for the repair of products that are not covered by this limited warranty.

### 6. What must you return with the PRODUCT to get warranty service?

You must:

- a. Return the entire original package and contents including the PRODUCT to the service location along with a description of the malfunction or difficulty; and

## Limited warranty

- b. Include a “valid proof of purchase” (sales receipt) identifying the PRODUCT purchased (PRODUCT model) and the date of purchase or receipt; and
- c. Provide your name, complete and correct mailing address, and telephone number.

### 7. Other limitations

This warranty is the complete and exclusive agreement between you and the manufacturer of this AT&T branded PRODUCT. It supersedes all other written or oral communications related to this PRODUCT. The manufacturer provides no other warranties for this PRODUCT. The warranty exclusively describes all of the manufacturer’s responsibilities regarding the PRODUCT. There are no other express warranties. No one is authorized to make modifications to this limited warranty and you should not rely on any such modification.

State/Provincial Law rights: This warranty gives you specific legal rights, and you may also have other rights which vary from state to state or province to province.

Limitations: Implied warranties, including those of fitness for a particular purpose and merchantability (an unwritten warranty that the PRODUCT is fit for ordinary use) are limited to one year from date of purchase. Some states/provinces do not allow limitations on how long an implied warranty lasts, so the above limitation may not apply to you. In no event shall the manufacturer be liable for any indirect, special, incidental, consequential, or similar damages (including, but not limited to lost profits or revenue, inability to use the PRODUCT or other associated equipment, the cost of substitute equipment, and claims by third parties) resulting from the use of this PRODUCT. Some states/provinces do not allow the exclusion or limitation of incidental or consequential damages, so the above limitation or exclusion may not apply to you.

**Please retain your original sales receipt as proof of purchase.**

## Technical specifications

RF frequency band	1921.536MHz — 1928.448MHz
Channels	5
Operating temperature	32°F — 122°F 0°C — 50°C
Headset base voltage (AC voltage, 60Hz)	96 — 127 Vrms
Headset base voltage (AC adapter output)	6VDC @300mA
Headset voltage	3.2 — 4.2 VDC
Replacement battery	3.7V 240mAH

### DECT 6.0 digital technology

Digital Enhanced Cordless Telecommunications (DECT) 6.0 is a new frequency band that transmits your voice across multiple channels. This technology provides superior quality of voice and sound, high protection against wiretapping and better range than 2.4 GHz and 5.8 GHz phone systems, while not interfering with wireless routers.

### Operating range

This cordless headset operates within the maximum power allowed by the Federal Communications Commission (FCC). Even so, this headset and headset base can communicate over only a certain distance — which can vary with the locations of the headset base and headset, the weather, and the construction of your home or office.

### Extended range and clarity

Experience the best in long-range coverage and clarity, provided by a unique antenna design and advances in noise-filtering technology. The TL7610 is a fully cordless DECT 6.0 headset offering a range of up to 500 feet. Open range test was performed by Wyle Laboratories, an independent commercial test facility. “Up to 500 feet” cordless headset range refers to the maximum open field range. Actual range may vary depending on intervening obstacles. Sound level protection technology conforms to the current regulations and is used to filter out the loud and high-pitched noises.

Index  
Index

**A**

---

- AC adapter, 14, 15, 16
- Adjust the lifter audio, 17
- Alert tones, 3
- Answer calls, 30
- Auto off, 31

**B**

---

- Battery charging, 10
- Battery installation, 8

**C**

---

- Call waiting, 32

**D**

---

- Deregistration, 21
- DSL, 12, 14, 15, 16

**E**

---

- Ear hook, 22
- Ending calls, 31

**F**

---

- Flash (switch hook flash), 32

**H**

---

- Headband, 26
- Headset buttons, 1–2
- Headset operation, 29–31

**I**

---

- Incoming calls
  - answer, 30
  - end, 31
- Indicator lights, 1, 6
- Intercom, 34
- Intercom call transfer, 34

**L**

---

- Lights, 1, 6
- Listening volume, 32

**M**

---

- Maintenance, 49
- Making calls, 29
- Multiple headset/
  - handset use, 34
- Mute, 35

**N**

---

- Neckband, 28

**O**

---

- Operating range, 59

**Q**

---

- Quick reference guide, 1–3

**R**

---

- Receiving calls, 30
- Registering headsets, 20
- Replacing headsets, 21

# Index

## **S**

---

Safety information, 45–48

Speaking volume, 32

Switch a call, 33

## **T**

---

Technical specifications, 59

Temporary ring tone

    silencing, 31

Troubleshooting, 36–44

## **V**

---

Volume controls, 32

## **W**

---

Warranty, 55



**[www.telephones.att.com](http://www.telephones.att.com)**

© 2008-2012 Advanced American Telephones. All Rights Reserved.  
AT&T and the AT&T logo are trademarks of AT&T Intellectual Property licensed to  
Advanced American Telephones, San Antonio, TX 78219.  
Synapse® and SynJ® are trademarks of Advanced American Telephones.  
Printed in China. Issue 9 AT&T 10/12.